

High Speed Door Albany UltraFast



**UNITED STEEL
PRODUCTS, INC**

33-40 127th Place
Flushing NY 11368

P: (718) 478-5330 F: (718) 779-8258
www.UnitedSteelProducts.com

ASSA ABLOY

ASSA ABLOY Entrance Systems

The global leader in
door opening solutions

Speed Up Productivity
and Savings





Wireless

No wires or coil cords, eliminating unnecessary maintenance.

Fast Opening and Closing Speeds

Opens in seconds, improving operations and traffic flow, while limiting air infiltration and lowering energy costs.

Tight Sealing

Weather-tight sealing around full door perimeter reduces energy loss and keeps out dust, dirt and outdoor elements.

Heavy Duty Wind Ribs

Resists high winds to keep door intact in adverse conditions.

The Albany UltraFast delivers high speeds of up to 60” per second and a superior design for optimal productivity, reliability and safety.

Fast speeds and a true breakaway bottom beam provides efficiency for high traffic areas. High windload resistance and tight seals provide protection for exterior applications. From ASSA ABLOY Entrance Systems, the global leader in door opening solutions, the Albany UltraFast saves on energy costs, increases productivity and keeps workers safe.

High Speeds, Low Maintenance

Suited for a range of applications, The Albany UltraFast is the cost-efficient solution for busy areas that require tightly-sealed separation from outdoor conditions, or from other sections of a facility.

- Opening speeds of up to 60” per second plus an option that boosts speed up to 100” per second.
- Breakaway Bottom Beam automatically resets itself after impact, saving on energy and maintenance costs, while maintaining the flow of operations.

Protection for Exterior Applications

Wind rib reinforcement and strong polyurethane weather seals allow the Albany UltraFast to hold up against exterior conditions without limiting fast speeds.

- Double weather seals run along the side frames, and along the front and back of the header for a smooth, tight seal around the entire frame of the door.
- Heavy-duty wind ribs are secured within the side frames for additional wind resistance.



Keep Workers Safe

Smart design and reliable safety features help reduce lost-time accidents, and protect workers and equipment.

- Wireless Safety System eliminates coil cords, and the high maintenance costs and lengthy down time associated with them.
- Optional Safety Light Curtains provide a 6-foot high grid of infrared beams across the doorway. If that grid is interrupted, the door will automatically reverse to the open position.
- Optional Egress Safety System is an easily accessible brake release that automatically raises the door in case of a power outage or other emergency.

Lower Total Costs of Ownership

The Albany UltraFast adds considerable value to your top and bottom line. You'll improve workflow, enhance safety, and save on energy and maintenance costs.

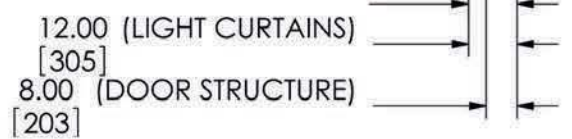
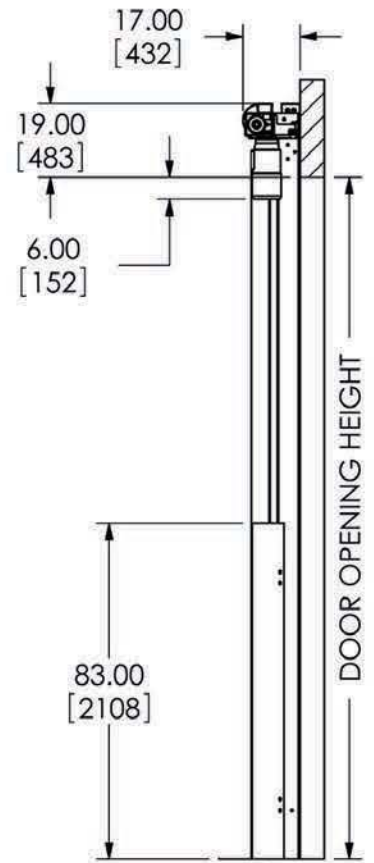
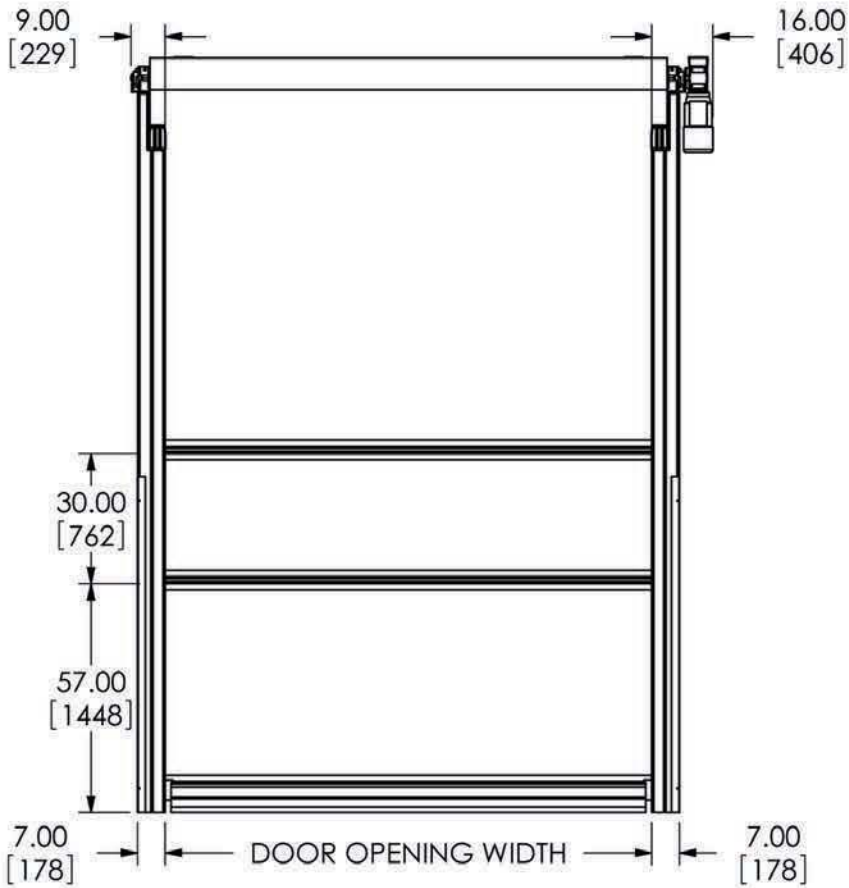
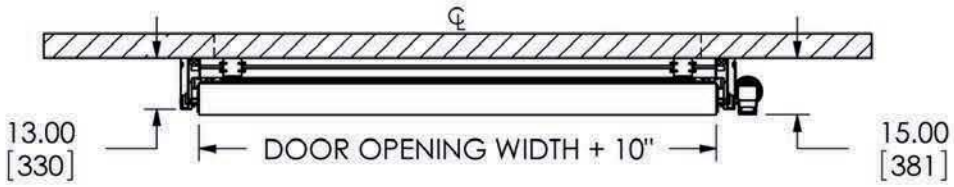
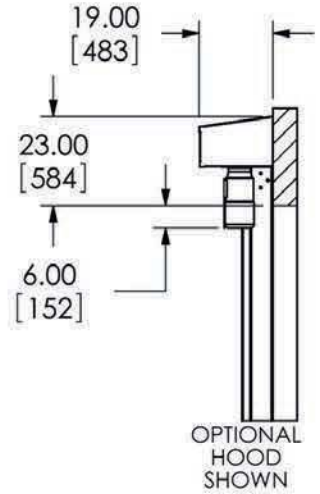
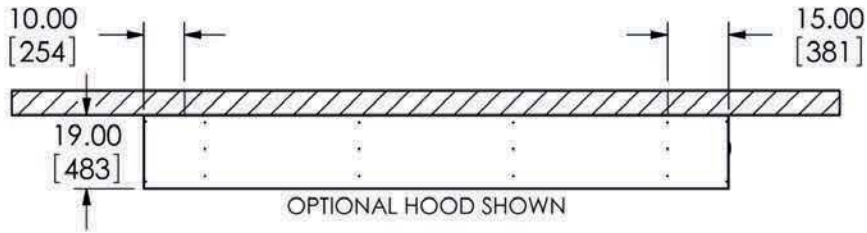

Technical Specs

Opening and Closing Speeds

| | |
|---------------|----------------|
| Opening up to | 60" per second |
| Closing up to | 24" per second |

Door Dimensions

| | |
|------------|-------------------|
| Max Height | 20 ft (6,096 mm) |
| Max Width | 20 ft. (6,096 mm) |
| Min Height | 7 ft. (2,133 mm) |
| Min Width | 3 ft. (914 mm) |

Safety Features

| | |
|------------------------|--|
| Photo Eye | Standard |
| Safety Light curtain | Full through-beam light curtain up to six feet tall |
| Wireless Safety System | No coil cords |
| Bottom Beam | Padded, soft bottom bar has fail-safe electric safety edge |
| Egress Safety System | Break release raises door during power outage |

Door Panel

| | |
|-------------------------|--|
| Rolltex™ | Premium Option-Manufactured by ASSA ABLOY for the Albany brand |
| 2-ply | Woven monofilament polyester PVC impregnated panel material. |
| Vinyl | Optional - 40 oz replaceable panel material. |
| Full Width Vision Panel | Full door width x 30" high PVC vision panel. |
| Windows | Optional - 17" x 17" PVC windows. |
| Full Width Screen Panel | Optional. |

Door Components

| | |
|-----------------------------|---|
| Side Frames | Self-supporting 5" x 6" aluminum side frames |
| Breakaway Auto-Reset System | Door automatically resets after impact |
| Sealing | Double weather seals on top frame and side frames |
| Covers | Optional - top roll and motor covers |

Control and Drive System

| | |
|--------------------|--|
| MCC VectorControl™ | Variable frequency drive with soft start / soft stop and positioning encoder. 24V DC, cUL listed |
| Input Voltage | 208-240 V, 440-480 V, 575-600 V |
| Motor | Up to 3.0Hp, 3 phase, 50/60 Hz |
| Limits Adjustment | At keypad interface |
| Protection | NEMA 4 |

Wind Resistance

| | |
|----------------------------|------------------------------------|
| Wind Resistance | Up to 14 psf (75 mph) (121 km/hr) |
| Wind Rib Reinforcement | 1.5" aluminum profiles |
| For High Wind Applications | 4" high strength aluminum profiles |
| Wind Rating | 14psf |

We offer various options and actuation devices for all Albany products

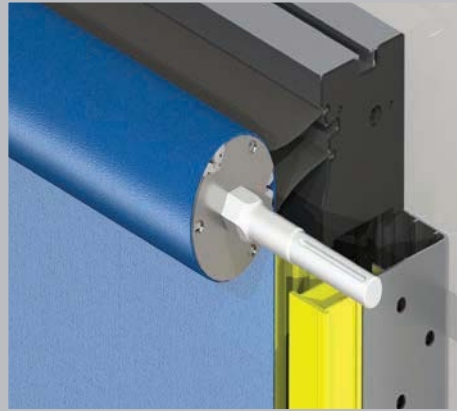

Double Weather Seals

Top frame and side frames seal when door is closed, reducing energy loss and maintaining climate control.

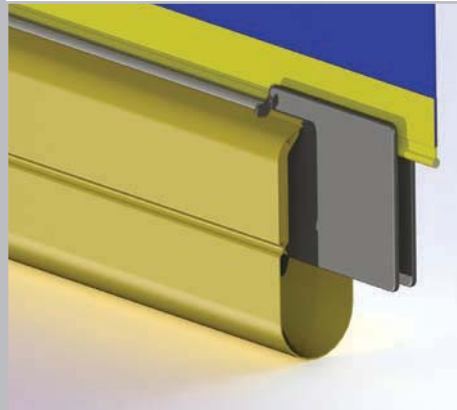

Breakaway Soft Bottom Bar

Soft, breakaway bottom bar automatically repairs itself after accidental impact and protects against injuries.



Light Curtain

Smart safety system eliminates contact with objects in door-way.

ASSA ABLOY Entrance Systems is a leading supplier of entrance automation solutions for efficient flow of goods and people. With our globally recognized product brands Besam, Crawford, TKO, Albany and Megadoor, we offer products and services dedicated to satisfying end-user needs for safe, secure, convenient and sustainable operations. ASSA ABLOY Entrance Systems is a division within ASSA ABLOY.

ASSA ABLOY

assaabloyentrance.us • assaabloyentrance.ca



© ASSA ABLOY Entrance Systems AB/PL/ULtraFas/USA/EN-1.0/1503 Technical data subject to change without notice.



ASSA ABLOY Entrance Systems

Tel: 1-800-252-2691
info.na.aaes@assaabloy.com
assaabloyentrance.us



**UNITED STEEL
PRODUCTS, INC**

33-40 127th Place
Flushing NY 11368

P: (718) 478-5330 F: (718) 779-8258
www.UnitedSteelProducts.com

Follow us:



Please enter ASSA ABLOY Entrance in the channel's search field.